 1=3.76m 2=3.16m 3=2.68m

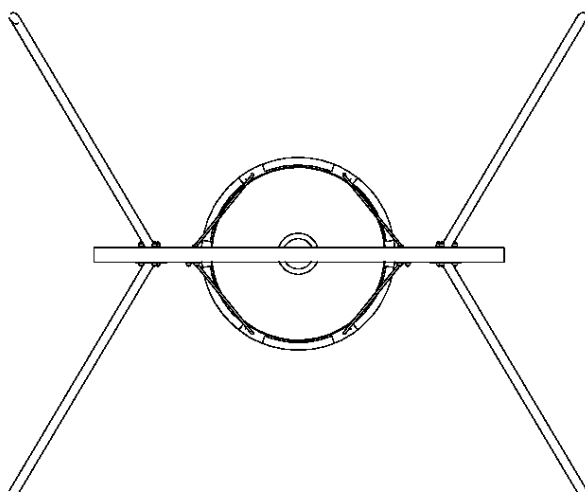

PLAY VALUE

swinging
meeting



Levels of adaptation:

Motor disability

Sensorial Disabilities

Learning Disabilities



OTHER INFORMATION



5 players

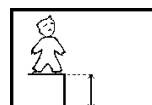

HCL= 2m

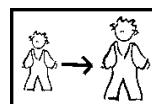

2-8 years old

Installation of equipment

Impact area = minimum safety surfacing required according to EN 1176-1

 Impact area

 Free space

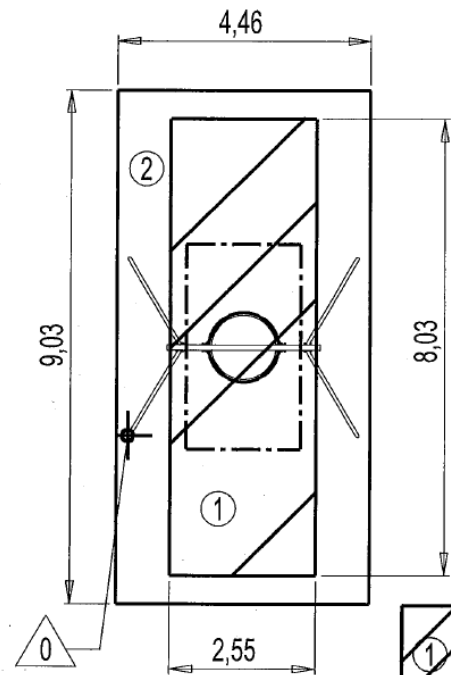

Point de Référence
Setting Out Point
Punto de referencia
Bezugspunkt

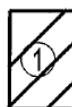
 Zone d'Impact Sol souple
Impact Area Wetpour
Area de Impacto
Fallraum

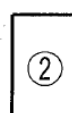
 Zone d'Impact Sol fluent
Impact Area Loose particle material
Arenero
Loses Bodenmaterial

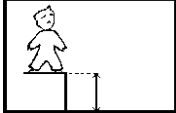
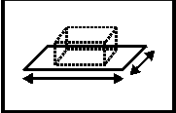
		
①	2m	20.5m ²
②	2m	40.5m ²

INSTALLATION

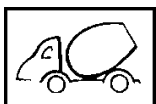

1.5m³



2

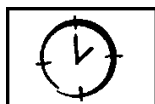

08H00

CERTIFICATIONS

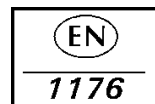

Proludic